

WSI - Serisi ISO 15552 Silindirler / WSI - Series ISO 15552 Cylinders

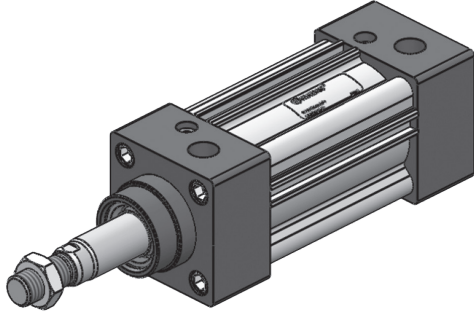

Özellikler / Specification

Piston Çapı / Bore Size	32	40	50	63	80	100
Çalışma Tipi / Acting Type	Çift Etkili / Double Acting					
Akışkan / Fluid	Hava (40µm filtrelenmiş) / Air (40µm filtered)					
Çalışma Basıncı / Op. Pressure	< 10 Bar					
Sıcaklık / Temperature	0 ~ +80 °C					
Manyetik / Magnetic	Standart / Standard					
Yastıklama Tipi / Cush. Type	Ayarlı Yastıklama / Adjustable Cushioned					
Hız / Speed Range	< 800 mm/s					
Sensör / Sensor Switches	WT-50 / WT-65 / WT-75					

Teknik Çizim / Technical Drawing

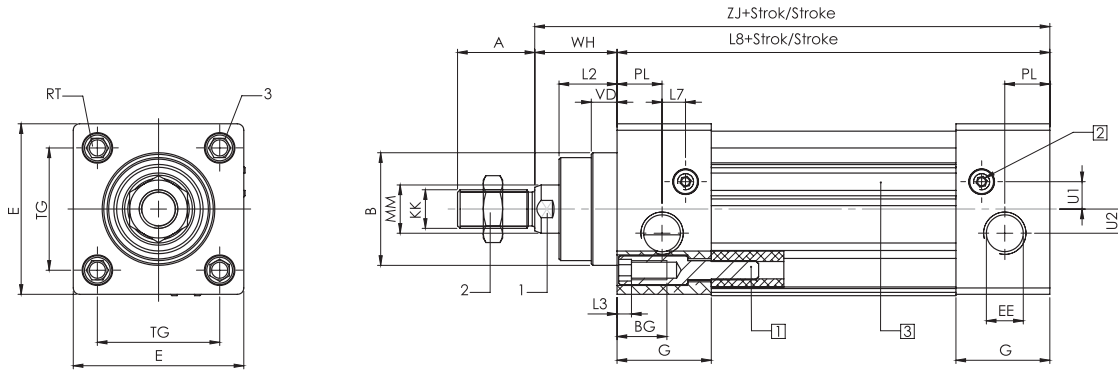











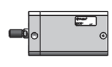

- 1 Kapak Bağlantı Cıvatası / Cover Mounting Screws
 2 Ayarlanabilir Yastıklama Cıvatası / Adjustable Cushioning Screws
 3 Manyetik Sensörü İçin Kanal / Sensor Slot For Magnetic Switch

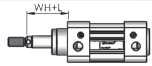
Ø mm	A -0.5	B Ø d11	BG min.	E +0.5	EE	G -0.2	U2 ±0.1	U1 ±0.1	KK	L2	L3 max.	L7	L8 ±0.4	MM Ø	PL ±0.1	RT	TG ±0.3	VD +0.5	WH +2.2	ZJ +1.8	1	2	3	YASTIKLAMA YASTIK UZUNLUĞU MAX. STROKE	MAX. STROKE
32	22	30	15.5	46.5	G1/8"	27.5	3.25	7.25	M10x1.25	16.0	4	4.5	93.5	12	14.0	M6	32.5	-	26.0	119.5	10	16	6	9.1	2000
40	24	35	15.5	53.0	G1/4"	29.5	7.50	8.50	M12x1.25	18.0	4	7.5	105.5	16	14.0	M6	38.0	-	29.5	135.0	14	18	6	13.1	2000
50	32	40	17.0	65.0	G1/4"	30.0	5.50	8.50	M16x1.5	25.0	5	6.0	106.0	20	15.0	M8	46.5	-	37.0	143.0	17	24	8	18.0	2000
63	32	45	17.0	75.0	G3/8"	31.0	7.50	7.50	M16x1.5	23.5	5	6.5	120.0	20	15.5	M8	56.5	40	37.0	157.0	17	24	8	19.1	2000
80	40	45	17.0	95.0	G3/8"	35.0	9.50	13.50	M20x1.5	30.0	5	9.0	128.0	25	17.5	M10	72.0	-	46.0	174.0	21	30	10	22.5	2000
100	40	55	17.0	115.0	G1/2"	36.0	13.50	14.50	M20x1.5	32.0	5	9.5	138.5	25	18.0	M10	89.0	45	51.0	198.0	21	30	10	23.0	2000
125	54	60	19.0	140.0	G1/2"	46.0	14.00	13.00	M27x2	44.5	6	12.0	160.0	32	23.0	M12	110.0	-	65.0	225.0	27	41	12	25.0	2000

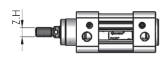
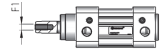
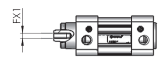
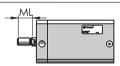
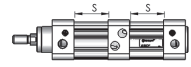
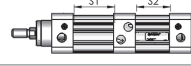
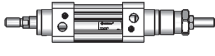
Sipariş Kodu / Ordering Code

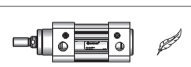
MODEL	MANYETİK MAGNETIC	YASTIKLAMA CUSHIONING	ÇAP DIA.	STROK STROKE	MİL MALZEMESİ ROD MATERIAL	MİL UZUNLUĞU ROD LENGTH	DIŞ TİPİ SCREW TYPE	DIŞ ÖLÇÜSÜ SCREW SIZE	DIŞ UZUNLUĞU SCREW LENGTH
WSI	M	YY	Ø80	Ø250	SS	L25	F	ZM18.H1.5	E15
M	:MANYETİK M :With Magnet	YY :YASTIKLI YY :Cushioned	PİSTON ÇAPI (mm) Piston Dia	STROK (mm) Stroke	SS :PASLANMAZ Inox	LX (mm) -	F :DIŞI Female	Zx :ÇAP Dia Hx :HATVE Pitch BOŞ :STANDART Blank :Standart	Ex (mm) BOŞ :STANDART Blank :Standart

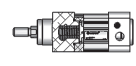
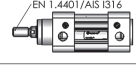
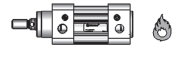
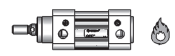
Opsiyonlar / Options

Sembol / Symbol	Özellik / Explanation	Kodlama / Coding	Çizim / Drawing
Standart	—	—	
Standart	—	—	
M	Manyetik / Magnetic	M	
YY	Yastıklı / Cushioned	YY	
L	Mili Uzun / Long Rod	.L50	
E	Farklı Diş Boyu / Special Thread Length	.E47	
X1	Mil Ucu Diş Kesik / Threadless	.X1	
Z...H	Farklı Diş Ölçüsü / Special Thread Size	.ZM10.H.1.25	
F1	Dişi Dişli / Female Thread	.F1.Z.M8	
FX1	Dişi Dişli, Mil Ucu Kesik / Special Female Thread	.FX1.Z.M8	
ML	Erkek Dişli / Male Thread	.ML	
T	Tandem / Tandem	.050.0100.T	
PT	Pozisyoner / Positioner	.050.0040.0025.PT	
J	Strok Ayarlı / Stroke Adjustable	.J	
D	Çift Millî / Through Rod	.D	
LR	Yağda Çalışabilen / Hydropneumatic	.LR	
LF	Düşük Sürtünmeli / Low Friction	.LF	
RS	Arka Yaylı / Rear Spring	.RS	
FS	Ön Yaylı / Front Spring	.FS	
SS	Paslanmaz Millî / Inox Rod	.SS	
V	Viton Keçeli / Viton Seal	.V	
VO	Viton Boğaz Keçeli / Viton Rod Seal	.VO	
FD	Gıdaya Uyumlu Yağlanmış / Greased Suitable Food	.FD	
C	Soğuğa Dayanım / Low Temperature	.C	